



PT230/PT360 PONTOON THRUSTER SYSTEM

INSTALLATION/OPERATION MANUAL

VOLUME 2.5, JULY 2023

Sideshift Inc. 130 Industrial Ave, Unit 303, Carleton Place, ON, Canada K7C 3T2
1.877.325.4787 +613.686.6011 INFO@SIDESHIFT.COM

INTRODUCTION

Thank you for your purchase of a Sideshift thruster system.

Sideshift thrusters are designed for easy installation by anyone with basic mechanical and electrical skills.

This manual explains everything you need to know about installing your Sideshift thruster.

We also provide unlimited telephone support at [1.877.325.4787](tel:18773254787).

Also see our website for helpful information and installation videos at <https://sideshift.com/resources/installation/>

This manual explains the mounting and operation of the PT230 and PT360 Pontoon Thruster systems. We recommend that you familiarize yourself with the complete manual before starting your installation.



Safety warnings



- WARNING:** To prolong motor life and prevent overheating operate the thruster in short bursts of 3-5 seconds, and never for more than 20-30 seconds at a time.
- WARNING:** Ensure thruster main battery switch is turned off when conducting maintenance and repair of the thruster.
- WARNING:** Use extreme caution when swimmers are in the area of the thruster. Turn off ignition and avoid contact with thruster props when boat is stationary.
- WARNING:** When operating out-of-water do not run thruster for longer than 5 seconds to prevent overheating.
- WARNING:** If conducting an in-water installation, use a cordless drill only, as a corded drill can present an electrocution hazard.

Required Tools





- Heat gun
- $\frac{3}{8}$ " drive cordless driver
- $\frac{3}{8}$ " hex socket
- Wire stripper
- Wire crimper
- SAE wrench set $\frac{3}{8}$ " to $\frac{3}{4}$ "
- Pliers
- Drill bits up to $\frac{1}{2}$ "
- Caulking gun
- 1 $\frac{1}{4}$ " and 2 $\frac{1}{2}$ " hole saw





Parts List

Item	Photo	Purpose
Single Joystick		Power, raise, lower and control thruster.
Dual Joystick(PT360)		Power, raise, lower and control bow thruster. Control stern thruster.
Wireless Receiver Module		Wireless receiver and control interface between joystick and motor controller for PT230 retractable thruster.



<p>Wireless Receiver Module</p>		<p>Wireless receiver and control interface between joystick and motor controller for stern thruster on PT360 system only.</p>
<p>Motor Control Module</p>		<p>Relays commands from joystick, delivering high current from battery to motor.</p>
<p>Threadlocker/Antiseize</p>		<p>Prevents screw and bolt threads from seizing, facilitating easier assembly and disassembly. PT360 systems only.</p>
<p>Heat shrink tubes (sufficient for all cables attached to motor controller. Cut to size)</p>		<p>Provides waterproofing for cable at battery terminals.</p>



<p>Terminal protectors</p>		<p>Protects terminals from moisture and prevents shorts.</p>
<p>Compression terminals and crimping tool</p>		<p>Terminal lugs for connecting thruster cables to batteries and motor controller. Lug crimper also included.</p>
<p>Wireless Remote</p>		<p>Controls bow thruster remotely on PT230 system, bow & stern thruster on PT360 system.</p>
<p>Battery Switch</p>		<p>On/Off switch for thruster battery.</p>
<p>Fuse/Digital Voltage Indicator</p>		<p>Fuse protection and voltage monitor.</p>



INSTALLATION INSTRUCTIONS

– PT230 PONTOON THRUSTER

Sideshift thrusters can be installed with the boat in water or on land, although land-based installation is easier.

To get an overview of the installation process you can view the pontoon thruster installation video on-line at <https://www.youtube.com/PT360>

You can also view these videos for help with mounting the bow thruster, and electrical/joystick connections.

[https://www.youtube.com/bow mounting](https://www.youtube.com/bow%20mounting)

[https://www.youtube.com/electrical joystick](https://www.youtube.com/electrical_joystick)

PT230 Bow Thruster Placement

The thruster is designed to be positioned on the underside bow of any dual or triple tube pontoon boat. For triple tube pontoon boats position the thruster between two pontoons on the helm side of the boat which will facilitate wire-runs. For dual pontoons position the unit centrally between pontoons.

The thruster cables pass through the deck and into storage typically found under the helm or under a hinged bench above deck.



Step-By-Step Instructions:

STEP 1: DETERMINE THE DISTANCE BETWEEN MOUNTING CROSS MEMBERS



The unit has pre-drilled mounting slots to accommodate either 16" or 24" centers. In some installations it will be necessary to drill the thruster mounting plate as seen below, to fit centers other than 16" or 24" using a 1/4" drill bit.





The thruster can also be mounted slightly back from the bow using mounting rails as shown above. View our video on attaching mounting rails for ease of installation.

NOTE: You will require a helper for Step 2

NOTE: The thruster should be positioned directly under the bow rail for best performance. The thruster can be mounted further back on the boat where it is less visible, but performance will be affected.

STEP 2: POSITION THRUSTER AND ATTACH TO UNDERSIDE OF DECK

1. Using a helper, position the thruster in place, and using the supplied self-drilling/self-tapping 1 ¼" stainless hex-head mounting screws, apply a small amount of supplied Loctite to the threads and drive the screws into the aluminum cross-members at the appropriate location. Pilot holes are not required. Two screws are required at the front and two at the back of the unit.



NOTE: For applications where the pontoon boat is being operated in rough water at high speeds, consider adding additional mounting screws or through bolts for greater strength.

STEP 3: FEED THRUSTER CABLES THROUGH DECK AND CONNECT TO MOTOR CONTROL MODULE, FUSE AND BATTERY SWITCH(REFER TO SCHEMATIC ON PG 14)

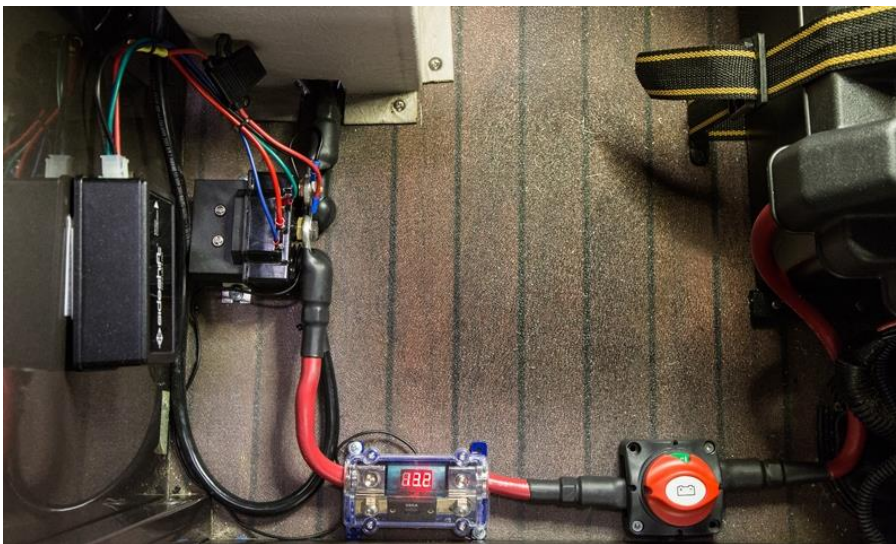

1. Determine a location for the motor control module, wireless receiver, fuse, battery and battery switch **in a dry storage area(Components are not waterproof)** close to the bow or under the helm. Use a waterproof box if necessary.
2. Using a 1 ¼" hole saw, drill holes at appropriate locations through the deck for routing of the thruster cables.
3. Route the motor thruster cables for connection **to a dedicated 12v 850CCA starter-type battery.**
4. Route 10 gauge charge wires from your house battery to the thruster battery *or* connect a 12v marine battery charger to the thruster battery.



WARNING: Verify that hole placement will not interfere with or damage anything when drilling through the deck and storage location, and that there is sufficient space so that cables can be accessed after passing through the proposed hole location.

WARNING: Ensure all electrical components are located in a dry storage area



INSTALLATION INSTRUCTIONS – PT360 BOW/STERN PONTOON THRUSTER SYSTEM

For bow thruster placement and installation, follow PT230 instructions above.

Stern Thruster Mounting

Caution: When operating the boat at high-speed trim the motor to ensure the thruster is just above the water surface. Failure to trim properly at high speed can cause heavy steering and may damage the thruster. <https://www.youtube.com/shorts/e2WZBSfPP4k>

Using the mounting plate as a template drill four 3/8" holes to the cavitation plate of the outboard motor. The plate can be attached to the top or bottom of the cavitation plate depending on the design of the motor. Bolt the mounting plate to the cavitation plate using the supplied hardware with the thread and nut in the upwards direction.

For single engine boats attach the stern thruster to the mounting plate with the thruster prop facing to the left(port) side of the engine.



Route the electrical cables through an appropriate opening in the stern using the included nylon sleeve and cable clamps. Use the included clamps and cable ties as required to ensure thruster cables are held securely. Note that there is one clamp with a larger 3/8" hole for attaching to the mounting plate bolt(see below). Cable clamps can be attached to the cavitation plate using the supplied bolts, or directly to the engine cover using the supplied screws.



Place a generous amount of supplied threadlocker on the threads and in the hole of each bolt. It is important that all thread and hole surfaces are well covered with threadlocker to prevent corrosion of the hardware and cavitation plate and to enable easy removal in the future.



Ensure that there is adequate cable clearance to compensate for movement of the motor side to side and vertically. On some engines the thruster cables can be routed through the engine cover. See examples of various methods below.





FEED THRUSTER CABLES THROUGH THE TRANSOM AND CONNECT TO MOTOR CONTROL MODULE, FUSE, WIRELESS RECEIVER AND BATTERY SWITCH(REFER TO SCHEMATIC ON PG 16)

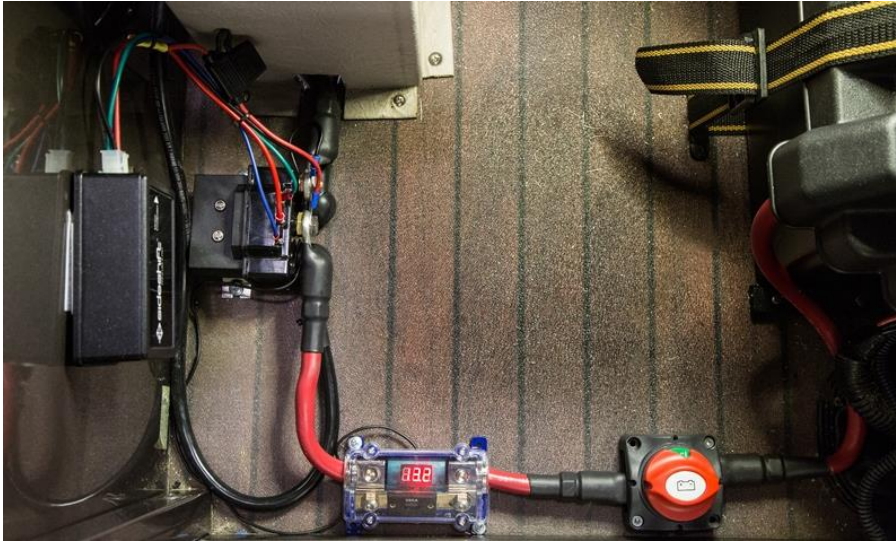

1. Determine a location for the motor control module, wireless receiver, fuse, battery and battery switch **in a dry storage area(Components are not waterproof)** close to the stern area of the boat. Use a waterproof box if necessary.
2. Route the thruster cables for connection **directly to the boat's existing starting battery(minimum 850CCA).**



INSTALLATION INSTRUCTIONS

– ELECTRICAL

Schematic – PT230 Bow Thruster

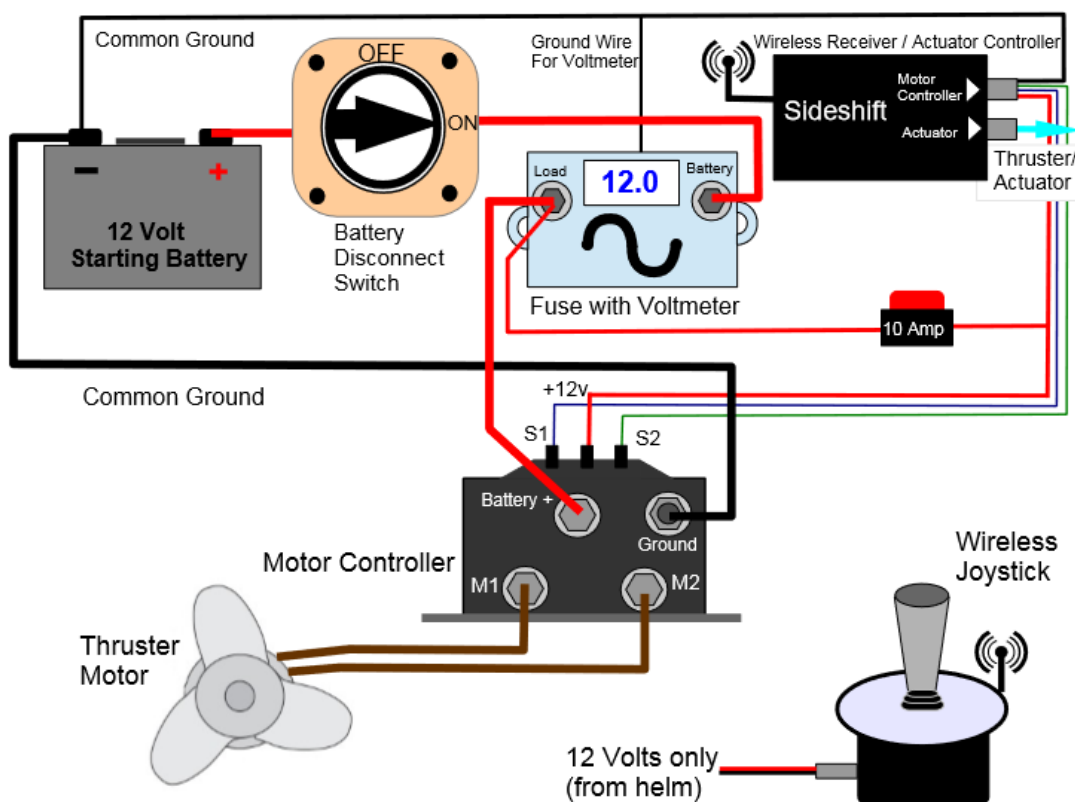

Schematic – PT360 Bow/Stern System

Note – Bow and Stern systems are identical on the PT360, with both thrusters controlled by a dual wireless joystick.

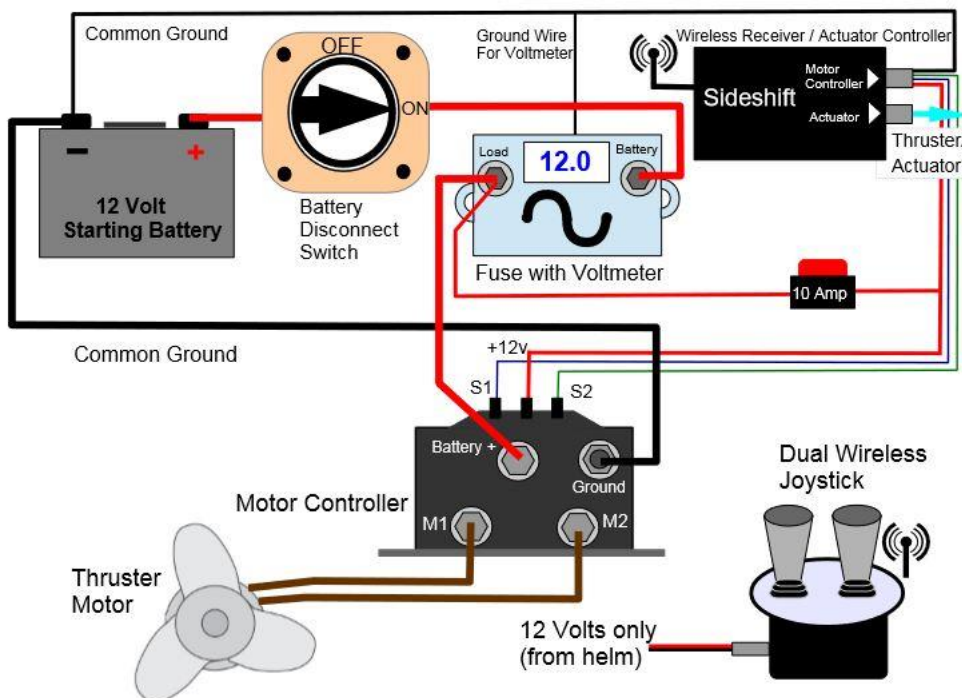

* Only on Retractable Thruster Receiver

Battery Requirements

A dedicated starter type battery (not deep cycle) to power the PT230 is required. Operating problems may occur when connecting the thruster(s) to an existing battery used for other purposes. The battery supplying the thruster(s) must be capable of meeting the required CCA (Cold Crank Amps), as outlined in Table 1: Required Battery Characteristics. **Insufficient battery capacity will lead to poor thruster performance.**

Model	Batteries Required	Voltage	Total CCA (A)
PT230	1	12 V	850
PT360	2	12 V	850 ea bow & stern

Table 1: Required Battery Characteristics

Note: For PT360 the boat's existing starting battery (Min. 850CCA) can be used for powering the stern thruster.



Warning: It is essential that the cold cranking ampere (CCA) requirements are met as outlined in the table above.

Ensure batteries are load tested and properly charged at all times to avoid performance problems and/or thruster motor damage due to low voltage

Batteries must be installed as close to the motor controller as possible for optimum performance. If you are installing batteries in a non-ventilated area you will need to use AGM (absorbed glass mat) sealed starter batteries.

BATTERY CAPACITY AND AGE

Under normal circumstances with new and fully charged batteries, you can expect around 50 thruster cycles before the battery must be recharged.

It is advisable to recharge batteries after each use if possible, to extend the life of the battery.

As batteries age and with repeated charge cycles, the battery slowly loses its ability to hold charge. The deeper the discharge before recharging, the shorter the life of the battery. Over time it will be able to supply fewer thruster cycles before it requires recharging and eventually will lack the capacity to allow proper thruster performance.

Capacity reduces to the point that performance is poor or few thrust cycles are available before recharging, and the batteries must be replaced.

BATTERY STORAGE

Over time, batteries self-discharge, even when disconnected. Some new batteries may have a self-discharge of 1-2% per month, but depending on the type and age of the battery, it can rise to 6% per month or more.

If the battery is coated with moist dirt and corrosion by-products, discharge rates can be even higher. Make sure the battery is clean and free of dirt and corrosion on and around the terminals.

If the battery is a flooded type, top up the electrolyte, ensuring that it is above the plates and below the vent cap well.

Fully charge the battery before storage, and store in a cool, dry place. Cooler batteries will self-discharge at a lower rate than warm batteries.



Check the terminal voltage of the battery periodically using the digital voltmeter located on the fuse holder. Check the voltage under load by operating the thruster by using the remote key fob. When the terminal voltage drops below 12.4 volts (75% capacity), charge it until fully charged. More frequent charging is preferred if possible.

Note that as charge capacity decreases, the freezing point of the electrolyte increases. This is important because the electrolyte must not be allowed to freeze. At 62% capacity, the freezing point is -26.5°C/-16°F; at 85% capacity, it is -52°C/-62°F.

WARNING: High currents can result in reduced voltage supply to the thruster if improper cable, connectors and/or assembly procedures are used. This can result in poor performance or damage to the thruster motor.

WARNING: Ensure the dedicated thruster battery is fully charged and load tested. Low battery voltage can result in erratic actuator performance (actuator arm will not extend or retract properly) and poor thruster performance or damage to the thruster motor.

Correct cabling and connection practices are essential for maintaining correct operating voltage. Batteries must be fully charged before use.

In most cases, the cable run from battery to controller is less than 10 feet, in which case 1/0 AWG cable is appropriate. For longer runs, use 2/0 AWG cable. Heavier cable can be used although it provides no performance advantage. If in doubt, increase the cable gauge.

Batteries are usually subject to moisture and damp/corrosive conditions, therefore it is important that the connection terminals are properly sealed to the cables using heat shrink tubing (supplied).

Terminal lug sizes are labelled as follows:

Thruster cables – Terminal lug part# M1 and M2

Battery to solenoid connection – Terminal lug part# T3-1

All other connections – Terminal lug part# T3-3



NOTE: If in doubt of which cable gauge to use, call Sideshift for technical advice.

Instructions:

STEP 1: CUT BATTERY CABLE TO LENGTH

1. Cut two lengths of marine battery cable of suitable length to reach from batteries to controller. Note that one cable may need to be longer than the other to accommodate the location of the battery terminals.

STEP 2: CONNECT BATTERY TO MOTOR CONTROLLER

1. Fit terminal protectors over each battery lead at the controller end.
2. Choose a terminal lug T3-1 to match the cable gauge (typically 1/0 AWG). See page [19](#) for instructions on how to install terminal lugs.
3. Attach positive cable to the "BATTERY POS" post on the motor controller. Slip battery protector over terminal.
4. Repeat steps for "BATTERY NEG" cable.

STEP 3: CONNECT BATTERY

1. Fit battery protector and then shrink tube to "BATTERY NEG" cable.
2. Install terminal lug to "BATTERY NEG" CABLE.
3. Attach positive cable to the LOAD side of the fuse.
4. Attach "BATTERY NEG" cable to battery terminal.

STEP 4: CONNECT THRUSTER TO MOTOR CONTROLLER

If thruster power cables are too long, cut them to length. Be sure that they are neatly routed, and comfortably reach the motor controller terminals. Leave some slack to make installation easier.

Fit battery protectors and then shrink tube over each thruster lead at the cable end.

Install terminal lugs to thruster cables(pg 19). Use terminal lug part# M1 and M2.

Connect one cable to "M1" and the other to "M2" on the motor controller solenoid.



NOTE: Motor power cable polarity is not identified. **If thrusters operate in opposite direction from joystick, reverse S1/S2 connections on motor controller**

How To Install Terminal Lugs

STEP 1: STRIP 1" (2.5 CM) OF INSULATION FROM EACH END OF CABLES

NOTE: Take care when stripping insulation to avoid damaging conductor. If some strands are removed the terminal may not make a good connection possibly resulting in performance reduction, a fire hazard or the cable pulling out of the terminal lug.

STEP 2: CHOOSE A TERMINAL LUG TO MATCH THE CABLE GAUGE

STEP 3: INSERT CABLE INTO TERMINAL LUG

STEP 4: FOLLOW INSTRUCTIONS INCLUDED WITH THE CRIMPING TOOL. NOTE: HIT CRIMPING TOOL ON A SOLID SURFACE WITH SEVERAL SHARP BLOWS. ENSURE CABLE IS PROPERLY SECURED TO THE LUG BY DOING A PULL TEST.

STEP 5: INSTALL HEAT SHRINK TUBE

1. Slide shrink tube up the cable so that it covers the shaft of the terminal and the insulation of the cable.
2. Apply even heat to the shrink tube until it makes a solid seal around the cable and terminal.



Installing Joystick on Console



1. Locate a position on the console of the boat suitable for the joystick. Check under the selected position on the console to ensure a minimum area of at least 4" diameter and a minimum three inches obstruction-free below the area of the joystick equipment.
2. Peel the backing and place the supplied template in the chosen location.
3. Using a 3/16" bit, drill a hole at the center of the template, marked by the cross-hairs.
4. Using a 2.5" hole saw and the pilot hole drilled in Step 3 above, drill a hole at the center of the template.
5. Remove the template.
6. Connect the red and black leads from the joystick power cable to a direct 12v source under the helm.

Note: Do not connect the joystick cable through an accessory or other type of switch.

7. Plug the power cable into the back of the joystick



8. Run a thin bead of marine sealant in the groove around the underside perimeter of the joystick, insert into the 2 1/2" cutout and press in place. Use a sharp knife or razor to trim any excess sealant.

CONNECTING MOTOR CONTROL MODULE, WIRELESS JOYSTICK AND ACTUATOR CONTROLS

Refer to PT230/PT360 schematics on page 15-16 for complete system layout

1. Position the wireless receiver module in a dry location near the motor control module.
2. Connect the red and black leads using the 4 pin motor control cable from the wireless receiver to "battery neg" and "battery pos".
3. Connect "battery neg" and "battery pos" on the battery to "battery neg" and "battery pos" on the motor control module through the fuse and battery switch.
4. Connect the blue and green leads using the 4 pin motor control cable from the wireless receiver to "switch 1" and "switch 2" on the motor control module.
5. Plug the 6 pin actuator cable into the black wireless receiver module.

Note: Only the retractable bow thruster requires the 6 pin actuator cable. The stern thruster system(PT360) wireless receiver does not have the actuator cable port.



NOTE: The joystick and wireless key fob are preprogrammed for operation. No pairing or programming is required.

OPERATING THE THRUSTER(S)

WARNING: The bow thruster is equipped with an overload protection circuit. Should the thruster encounter an obstruction when being retracted or deployed, the unit will shut down and a continuous alarm will sound. You must turn power off and then power back on to the joystick and to the main thruster battery switch, which will reset the unit. Clear any obstruction under the boat and proceed normally.

WARNING **Ensure the bow thruster is retracted before accelerating otherwise serious damage will occur to thruster components**

WARNING: Deploy and operate the thruster only when the boat is at docking speed or stopped. Never deploy the thruster when the boat is at speed as this will damage the unit.

WARNING: Ensure the area under the boat is clear when operating the thruster and that there are no swimmers in the area.

1. Turn power on to the joystick by holding the power button for 1 second. A beep will sound and the blue joystick light will activate.



- To lower the bow thruster, press and release the down button on the joystick console. A fast beep will sound during deployment. A slow beep will sound and the blue light will flash when the thruster is in the fully down position and ready for use.



- Use the thruster(s) in short 3-5 second bursts for optimal performance. **Do not run for more than 15-20 seconds at a time.**
- To retract the bow thruster push the up button on the joystick console. A fast beep will sound. When the unit is fully retracted the joystick will automatically power off.



OPERATING THE WIRELESS REMOTE

- For operation of the wireless key fob the joystick must be turned on and the thruster in the fully down position.
- Push the top left or right buttons as required to operate the bow thruster.
- Push the bottom left or right buttons to operate the stern thruster(PT360 only).



4. The wireless key fob will automatically power-off after 5 seconds to preserve battery life. To restart just push any button on the keyfob, assuming the joystick is still powered on.
5. A flashing green light on the keyfob indicates low battery. No green light when the system is turned on indicates a dead keyfob battery or lost wireless connection.
6. To replace the battery remove the 4 screws, open the case carefully, and insert a new CR2032 coin cell battery.
7. **Note: When battery is replaced the keyfob must be re-paired to the receiver. See instructions below.**
8. To reprogram the keyfob remote turn on joystick and hold top two buttons down on remote for 5 seconds until there is a beep. Check for thruster operation.

OPERATION AND FAULT MODES

Operation	Action	Features
Power on thruster	Press and hold joystick power button for 1 second	<ul style="list-style-type: none"> • Short beep and solid blue light to confirm power
Lower thruster	Push and release actuator down button on joystick	<ul style="list-style-type: none"> • Fast beep during deployment • Slow beep and flashing blue light when fully extended
Operate thruster	Push joystick left or right as required	
Retract thruster	Push and release actuator up button on joystick	<ul style="list-style-type: none"> • Fast beep when thruster retracts • System will power-off automatically once thruster is fully retracted



Failure mode	Alarm	Action
Thruster arm obstruction	Solid beep Thruster will power-off	<ul style="list-style-type: none"> • Clear obstruction or slow down when deploying or retracting thruster • Power off and on thruster main battery switch • Power off and back on to joystick • Operate as normal
Failure mode	Alarm	Action
Thruster arm not fully extending or thruster motor not operating	Slow flashing blue light on joystick indicating low thruster battery voltage	<ul style="list-style-type: none"> • Check thruster battery voltage • Load test battery • Check charging system • Ensure fully charged battery • See above section on battery maintenance

KEY FOB OPERATION

Mode	Action	Features
Power on	<ul style="list-style-type: none"> • Thruster must be in extended position before using key fob • Press left or right arrows to operate thruster as required 	<ul style="list-style-type: none"> • Solid green light when power on • Auto power-off after 5 seconds of non-use • Flashing green – Low Battery • No light – Dead battery or lost wireless connection • To reprogram remote turn on joystick and hold top two buttons down on remote for 5 seconds until there is a beep. Check for thruster operation. • Replace CR2032 coin battery if necessary



MAINTENANCE

Sideshift thrusters are designed for long life, provided proper maintenance procedures are followed.

WARNING: When working near or on the Sideshift thruster, always turn thruster battery switch to “off” position.

Motor Unit

The motor unit is sealed and requires no maintenance.

Battery

Ensure batteries are always fully charged. **Refer to the digital voltage indicator found on the fuse holder.** Unlike other battery technologies such as NiCad, batteries should be lightly cycled. Avoid discharging beyond 75% capacity and even less if possible. To verify charge, measure the terminal voltage of the battery with **no load**, and refer to the chart below to determine the health of your battery:

Voltage	Specific Gravity	Approximate Charge*
>14.4		Over-charging**
>13.38		Charging
12.62	1.265	100%
12.54	1.251	90%
12.45	1.236	80%
12.4	1.225	75% ***
12.27	1.206	60%
12.18	1.19	50%
11.97	1.155	25%
11.76	1.12	0%

Table 2: Terminal voltage vs. battery capacity



- Note * It can take 2 hours after charging for the terminal voltage to properly reflect the charge level.
- Note ** Over-charging can damage the battery and cause hydrogen gas to form which is an explosion hazard and can lead to serious injury and fire.
- Note *** Avoid discharging beyond 75% to avoid premature battery failure.



WARRANTY

2 Year Warranty

All Sideshift Inc. products are warranted to be free from defects due to faulty workmanship or defective materials for a period of two years. Products failing within the warranty period should be returned to Sideshift assembled and complete with a copy of the original invoice.

Return requests must be made directly to Sideshift. The request should include an itemized list of material, stating the reason for the requested return. Upon approval Sideshift will assign a Return Merchandise Authorization Number which must be placed on the return shipping container. Delivery of returned merchandise will be refused and credit will not be issued without written authorization and shipping instructions from Sideshift.

Sideshift Inc. will not be responsible for accidental damage or expense caused by the following conditions:

- Damage due to improper installation
- Improper wire size or low voltage conditions
- Burn-out due to overloading motor or related damage
- Water exposure to electronic components
- Tampering with or altering the motor before, during or after installation
- Damage due to collision of any kind
- Damage due to failure to retract thruster when at speed
- Damage due to entanglement of foreign objects such as fishing line and netting material
- Warranty does not cover paint damage, dents, nicks and normal wear and tear of the product following delivery and installation.



SPECIFICATIONS

Parameter	PT230
Power (HP)	2.5
Voltage (VDC)	12
Start Current (A)	300
Housing Length (in)	34.0
Thruster Arm Length (in)	35.0
Housing Width (in)	12.0
Propeller (in)	8.0
Recommended boat size (ft.)	<35.0
Actuator deployment/retraction time (sec.)	6.0

Parameter	PT360 Stern
Power (HP)	2.5
Voltage (VDC)	12
Start Current (A)	300
Propeller (in)	8.0
Recommended boat size (ft.)	<35.0

Wireless Receiver

Parameter	Value
Supply voltage	12VDC
Frequency	2.5Ghz

Sideshift Inc.
130 Industrial Ave, Unit 303
Carleton Place, ON, Canada K7C 3T2

Toll free. 1.877.325.4787
Tel. +1.613.686.6011
Fax. +1.613.225.9599
www.sideshift.com

